

Spectus
WINDOW SYSTEMS



Legacy

PVCu Sliding Sash Windows





Period Style

The *Legacy* PVCu Sliding Sash Windows carry all the beauty of a traditional design, combined with modern industry thinking that not only enhance the ease of fabrication, installation and day-to-day use.

From near-invisible joints, the grace of the run-through sash horn to the curvy ovolo frame shape, these are just a handful of the many clever details that work together to create the most graceful and advanced Sliding Sash Window on the market.

With the rise of PVCu Sliding Sash Windows being specified in premium developments, as homeowners recognise not only the elegance of this traditional style, but also its superior weather performance, four new colours have been introduced, providing additional choice and our stunning hardware range has become an art form, underpinned by underlying strength and security.



Contents

| | |
|--------------------------|---------|
| The Finer Details | Page 3 |
| Thermal Efficiency | Page 4 |
| Security | Page 5 |
| Features | Page 7 |
| Hardware | Page 10 |
| Colour Options | Page 11 |
| Obscure Glass..... | Page 11 |
| Styles & Shapes | Page 12 |
| Technical Info | Page 13 |

The Finer Details

Our PVCu Sliding Sash Windows hold a host of impressive features that not only add to its good looks, but also enhance the performance of the window. All parts of the stunning system has the crucial ovolo shape adding traditional character like no other.



Planning and Conservation

We're often faced with projects that require special features to fit in with the unique character of a conservation area. In the past, many planners used to refuse applications to replace timber sashes with a PVCu alternative. However, the Legacy Sash Window has been designed to recreate tradition, which has led to an increasing number of approvals granted.

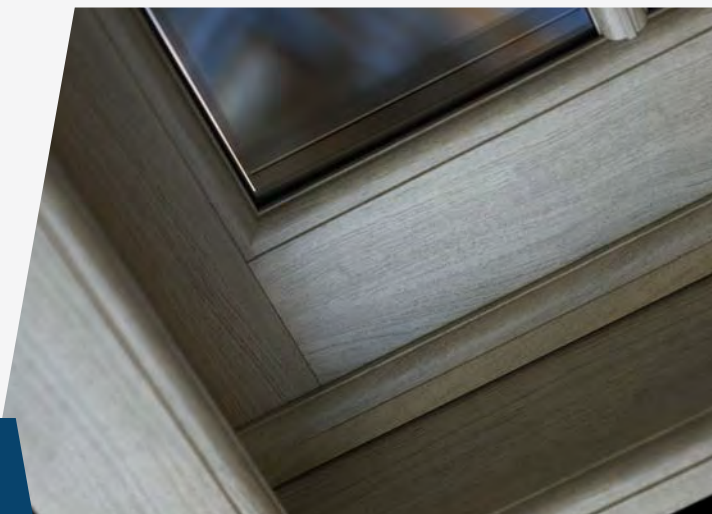

Exceptional Thermal Efficiency

With fuel prices constantly on the rise, thermal performance is crucial. The window frames are built to last and to resist the ever-changing conditions the British weather throws at them without losing their immaculate appearance. An innovative dedicated weather bar add another level of defense against rainwater; a feature unique to this type of window.



'A' Energy Rating Available

The frames and sashes are multichambered, using the power of air as an insulator to stop warmth escaping. Our sash windows are available with 24mm argon gas filled double glazed units enabling them to achieve an outstanding energy rating of 'A'.

The efficient air filled sash window unit achieves an energy rating of 'B' as standard and a u-value of 1.4/Wm²K.

Colourmatching Woolpile

The sash windows feature woolpile strips that provide an excellent seal against weather, air and debris infiltration. We've paid attention to every detail and as something new we've developed colourmatching woolpile to ensure that every single window is perfectly finished.



Recyclability

PVCu can be recycled over and over again, without any deterioration in performance. PVCu is an environmentally friendly choice as most PVCu windows will be recycled.

By choosing our sliding sash windows you are not only keeping your home warm all year round and reducing your heating bills, you're also helping the environment.

Peace of Mind

Our sash windows deliver the most advanced levels of security without adding complex operation. They are practical and come with all the safety features you need. The window is secured using a snail cam fitted to the top face of the bottom sash. By turning the lever you release the cam from its keep. You have the option of choosing a key-locking or non-locking system.

Our traditional sash window is backed up by an impressive list of accreditations:

- Kitemarked to BS EN 12608 and PAS 24
- Produced entirely in the UK
- Secured by Design accredited
- Compliant with Building Regulations
- 10-year manufacturing guarantee



PAS 24 and Secured by Design

Upgrade the security of your sliding sash windows by taking advantage of our PAS 24:2016 and Secured by Design security package. This enhancement includes the following four upgrades. This is generally mandatory on new-build projects. Please note that the upgrade is not standard and must be requested as part of the window specification.



Reinforced
Tilt Latches



Upgraded
Locking keep

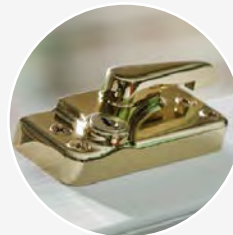

Upgraded
Locking x2

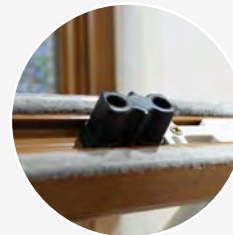

Top Sash
Security Blocks



Legacy Features

With our Legacy sash windows, you can respect the traditions, admire the woodworker's art and enjoy modern advances that make your home warm and secure. From a terraced house to a stately home, our sash windows ensure that your property retains its character and charm. You can choose from a wide range of styles, features and hardware options to complement your home.



Slide and tilt facility

As standard, our sliding sash window comes with a slide and tilt facility*, allowing you to clean both the top and bottom sash from inside your home.

Sash Horns

Enhance your window by choosing either run-through or plant-on sash horns. The run-through utilises mechanical joints rather than welded to allow the horn to be a continuous part of the sash giving the window a more authentic overall look.

The plant-on is a sculptured moulding that is fixed to the underside of the top sash.

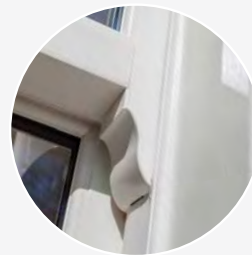

Run-through



Plant-on

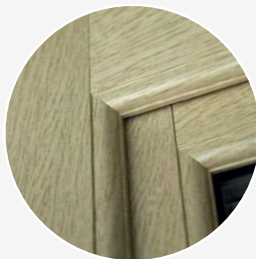

Mechanical Joints

The fully mechanically joints take authenticity to another level because the 45 degree PVCu welds on the frame and sash are replaced with 90 degree mechanical joints as found on traditional timber windows.

Seamless Welds

This revolutionary process disguises the external 45-degree corner welds with a flush mitre providing a far superior aesthetic finish. Available on woodgrain windows only and a minimum window size of 475mm wide x 900mm high.

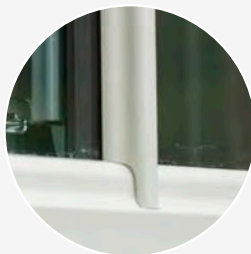
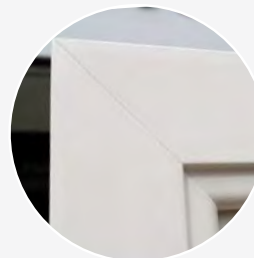

Astragal Bars

Include a bar layout on your new sash windows for added character and design that looks as close to the original as possible. Astragal bars are fixed onto the surface of the glass and are accompanied by back to back spacer bars inside the double glazed unit.

*Please note that on windows with a woodgrain finish external and smooth finish internal we are not able to offer top sash tilt facility.



Deep Bottom Rail

Choose a deep bottom rail if you want your sliding sash windows to look as close to the original timber version as possible. The larger bottom rail sash convincingly mimics the timber sash windows of old. The deep bottom rail is available with welded or mechanical joints.

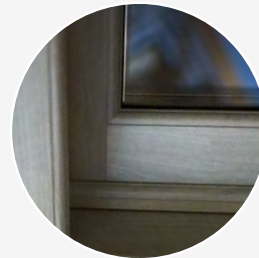

Weather Bar

The sash window boasts an innovative weather bar that not only offers authentic period aesthetics but also adds another level of defense against rain and wind. The ovolo shaped weather bar replicates the sashes and outer frame, and is the latest of our design features, developed to create an authentic sash window appearance.



Hardware

Travel Restrictors

The travel restrictors limit the opening of the top and bottom sashes to approximately 100mm. They are primarily used as a safety feature in locations where opening restrictions are needed. The magnetic mechanism can be overridden from inside your home allowing for a larger opening.

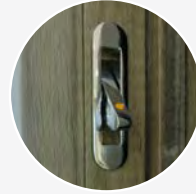

Sash Pull

All our PVCu Sliding Sash Windows come with one or two sash pulls as standard depending on window size. The sash pulls are usually fitted on the inside of the bottom sash to allow easy opening.

D Handle

Designed to be fitted to the underside of the top sash on the outside of the window to assist with the opening and closing of the window. Alternatively, you can request the D handle to be fitted to the inside top sash.

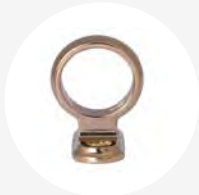

Pole Eye

Primarily designed to be fitted to the top rail of the top sash. The pole eye enables use of a pole with hook (not supplied) to operate any windows that are positioned too high to operate by hand.

Locking System

Our locking system holds the sash window shut by fastening the mid-rails together. The locking system is available in two styles.



Standard



Heritage



Standard

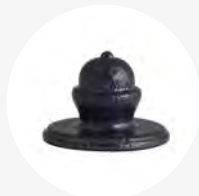

Heritage

Sash Knob

Used to open and tilt the sashes for easy cleaning of the outside frame and glass from inside your home.

Hardware Colours

Our hardware is available in eight different finishes. Please note that our travel restrictors are only available in white, chrome, gold and satin chrome.



White

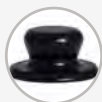

Black

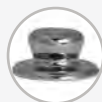

Chrome



Gold



Satin Chrome



Graphite

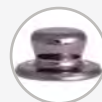

Bronze



Antique Black

Colour Options

Our sliding sash windows are available in twelve standard colours. By choosing a woodgrain foiled finish you are able to bring your windows to life with a glossy, freshly painted, realistic timber effect.



Bespoke Colour Bonding

If you're looking to add a true personalised touch to your new windows, we offer a bespoke colour bonding service in which you can choose between more than 1000 colours in either a smooth or woodgrain finish. Some of our most popular RAL colours are shown below. Please note that lighter / darker shades are available and we're always happy to help you find the perfect colour to suit your home. Just ask!



Obscure Glass

Obscure glass is typically utilised in bathrooms, shower rooms and other private areas. Our sliding sash windows can be specified with a variety of different glass patterns and obscurity levels to suit your needs.



Styles and Shapes

Our *Legacy* sliding sash windows can be manufactured to a style to suit your home. Below are a few examples of the different bar layouts available. Our windows come with equal sized top and bottom sashes (50/50 split) as standard, however we are able to manufacture other split ratios at your request (minimum transom drop of 350mm). Please get in touch if you require a bespoke style or bar layout.

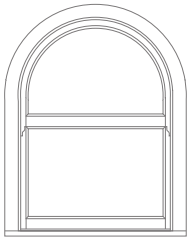
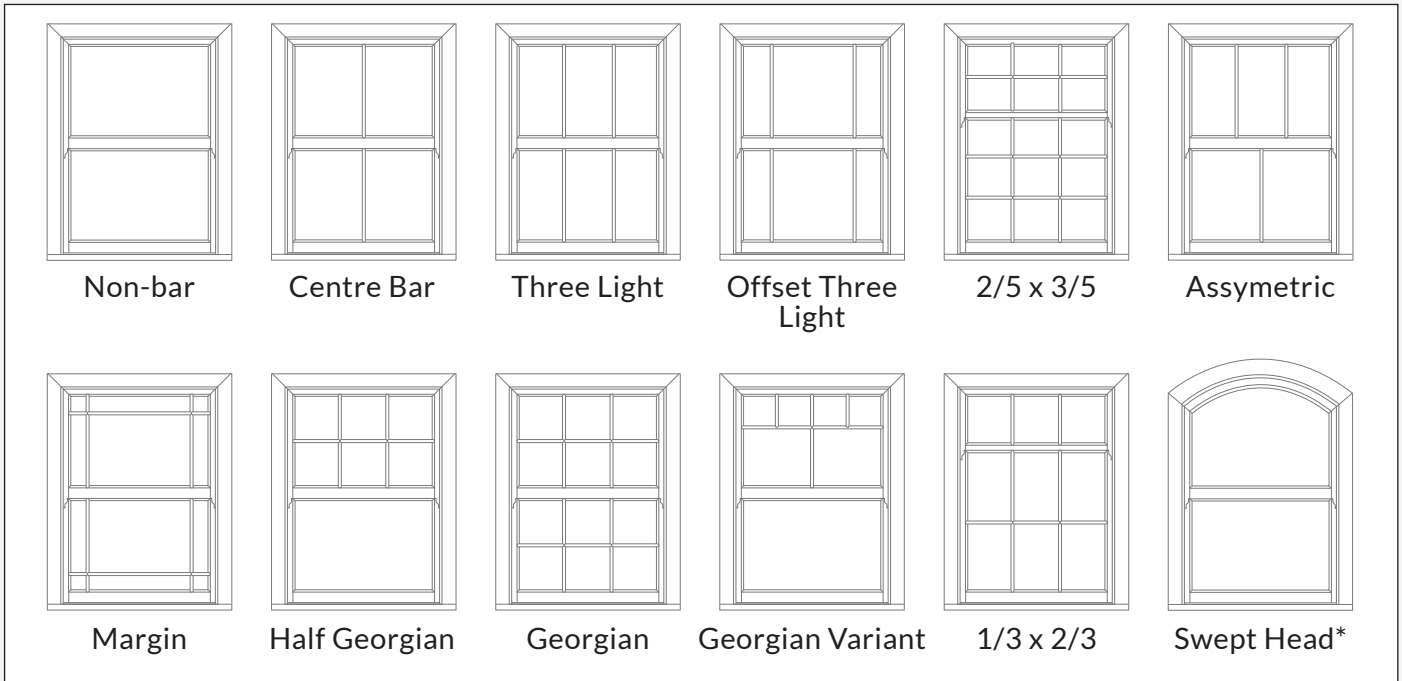

True Arch*

Seamless True Arch

PVCu sliding sash windows are notoriously difficult to work with when it comes to bending profiles and we're therefore very proud to be able to offer the only true arched PVCu sash window in the country with no welded joints in the frame.

Coupled and Bay Windows

Coupled- and bay windows are both very popular for large openings as they open up the living space and bring in natural light.

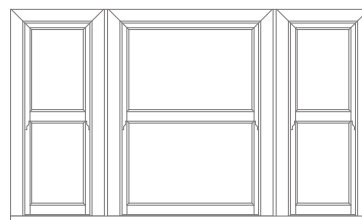

Coupled Windows

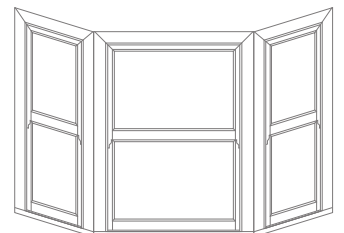

Bay Windows

*Please note that on swept heads and arched frames the top sash will always be fixed.

Technical Info

Our technical information section covers manufacturing limitations and detailed technical drawings. To most people the technical drawings don't make much sense, so if you have any questions our product experts will be more than happy to explain in more detail.

Technical Specifications

Front to back dimensions: 128mm
Glazing units: 24mm double glazed
U-value: 1.4W/m²K

Manufacturing Limitations

Minimum width: 360mm
Maximum width: 1500mm
Minimum height: 750mm
Maximum height: 2350mm

Technical Drawings

Main Profiles

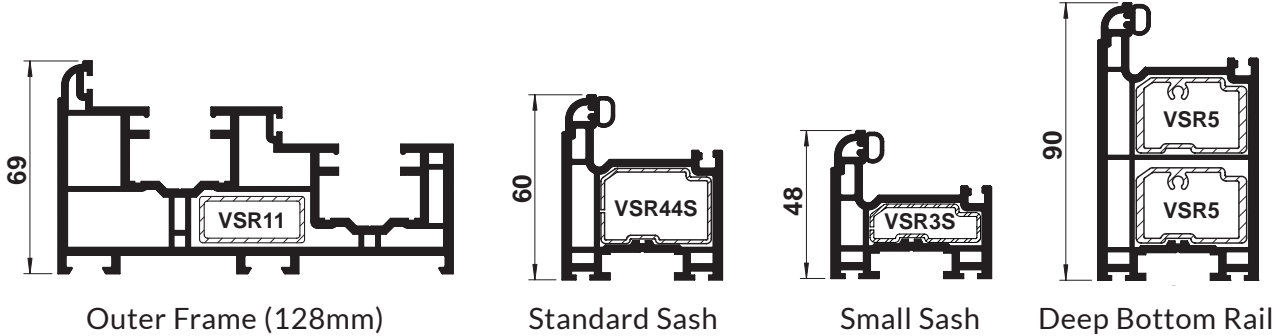

Sills

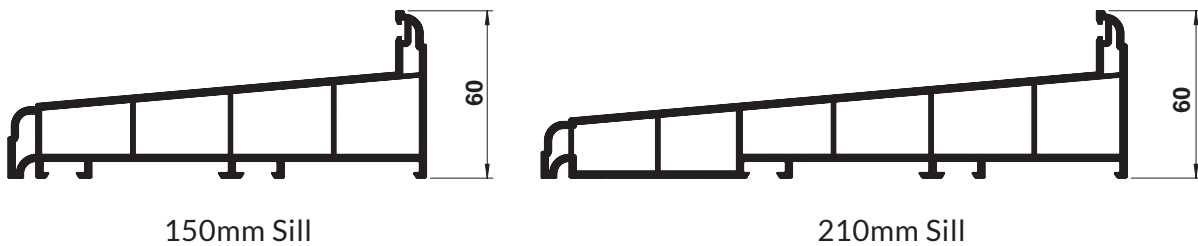

Ancillaries

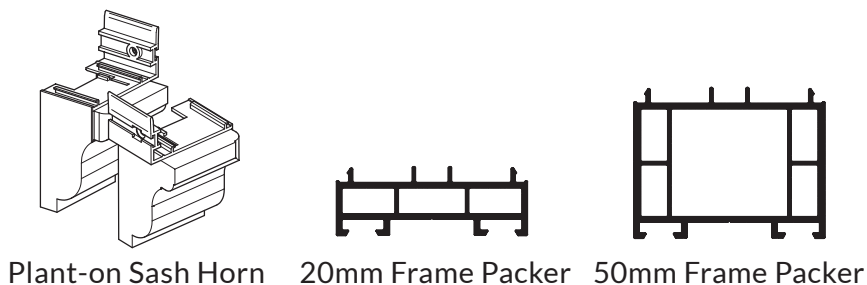

Please note that some slide and tilt restrictions may apply on very large/small and bespoke shaped windows.



The images, drawings and data shown in this brochure are for illustrative purposes only and are not binding in detail, colour or specification. We reserve the right to make changes to the product specification as technical developments dictate and without prior notice.

